

# Setting big things into motion.

## Ergonomics Meets Control Technology

INNOVATIVE



Control Unit  
KST 19



ERGONOMIC



UNIVERSAL



**GESSMANN**<sup>®</sup>

Industrial Controllers

# Ergonomic Meets Control Technology

## Rotatable KST 19 Control Unit

The rotatable KST 19 control unit was ergonomically designed and meets the highest requirements for comfort.

### Control panels

The KST 19 control unit features multi-functional control panels which can be moved sideways, turned and tilted by two handles on the underside of the panels. The panels can also be customized with individual operating devices. For this, Gessmann offers a large range of compatible joystick models as well as buttons, switches, control dials, control lamps and displays.



### Seat

The comfortable driver seat, featuring a pneumatic vibration absorption system and weight adjustment, offers a large range of adjustment options. With its air permeable cover, made of either artificial leather or textile material, the seat provides optimal comfort even during longer use.

### User Interface

The touchscreen that is integrated into the KST 19 control unit allows you to ergonomically control secondary processes and to carry out monitoring functions. Through the movable monitor arm and tiltable monitor case, the user interface can be perfectly adjusted.





## Unlimited/limitless use

At work, a good posture will significantly contribute to your well-being and to maintaining your work performance. With our KST 19 control unit, we can offer you the latest technology including the precision that is necessary for cranes and lifting equipment. We will also be happy to provide you with solutions that are customized to meet your demands.

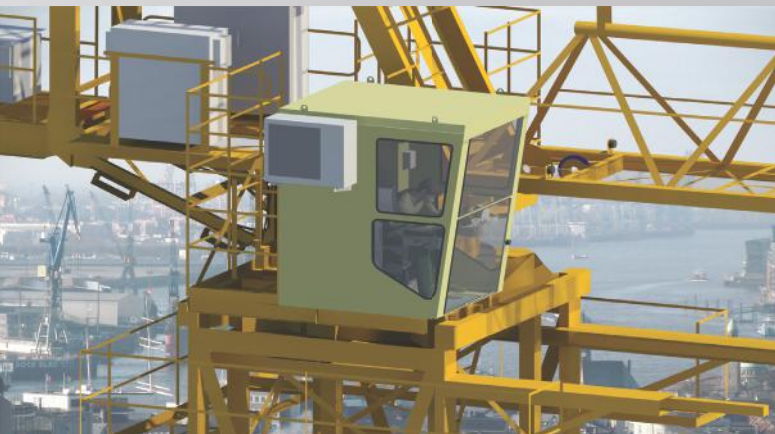

*“From use in tower cranes...*

*...to ship-to-shore solutions...*



*...to control rooms for gantry cranes serving hopper/bunker systems.“*



Whether it is used for a crane or a hopper/bunker system – with its special design, the KST 19 control unit can be used for the most different/many different applications while at the same time it ensures safe processes and optimal comfort.



# Ergonomics Meets Control Technology

## Scientifically proven

Under ergonomic as well as under medical aspects, it is recommended that one changes the body's position regularly. Our KST 19 control unit, with its multi-functional adjustable control panels, offers the unique option to switch between a sitting or standing position while working. This minimizes the risk of musculoskeletal disorders resulting from one-sided strains that typically occur with this type of work.



In the course of a scientific study conducted by the Chair of Ergonomics of the Technical University of Dresden, in cooperation with the GWT-TUD GmbH, the KST 19 control unit was tested and assessed under ergonomic aspects. For this, typical use scenarios and activities were examined, taking into consideration the latest findings. Optimal adjustability of the control unit with respect to many different user collectives was assessed according to anthropometric standards, usability and comfort experience.

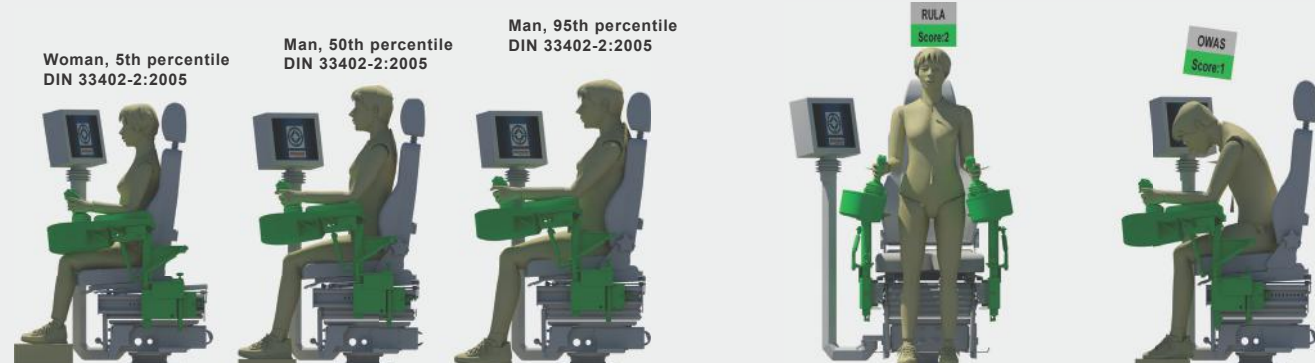

### Anthropometry

- Anthropometric validation by testing different percentile values for women and men
- Examination based on body dimensions in accordance with DIN 33402-2:2005

### Posture analysis

- Assessment of posture during seated or standing operation by means of OWAS
- RULA-analysis of the left and right hand-arm system



# Usability

Comprehensive usability tests as well as comfort studies carried out for the KST 19 control unit in the course of the study confirmed the results of the software-based assessments.



The results were compared to the requirements of national and international standards. The posture and ergonomics values were compared to the data from the ISO 11226 and DIN EN 1005-4 standards.

## Usability and comfort

Different postures while sitting or standing in specific scenarios (unobstructed view, looking down, looking up) were tested using a selected subject group consisting of women and men of all ages and percentiles. In addition, other subjective factors with respect to usability, adjustability and comfort were recorded.



# Ergonomics meets Control Technology

## Seat Comfort

For the best seat comfort, maximum pressure values in the range from 2 to 7 kPa are recommended for the area of the upper and lower back as well as the area of the upper thigh. These values could be scientifically proven for short-term as well as long-term use during the tests conducted on the KST 19 control unit.



### Pressure distribution measurements

To assess the seat comfort, an analysis of the measured pressure values was carried out in addition to the subjective evaluation through the subject interviews. This method is also used in the automotive industry to

optimize vehicle seat designs. The surface pressures on the seat and the backrest were determined by means of sitting tests in different working positions.

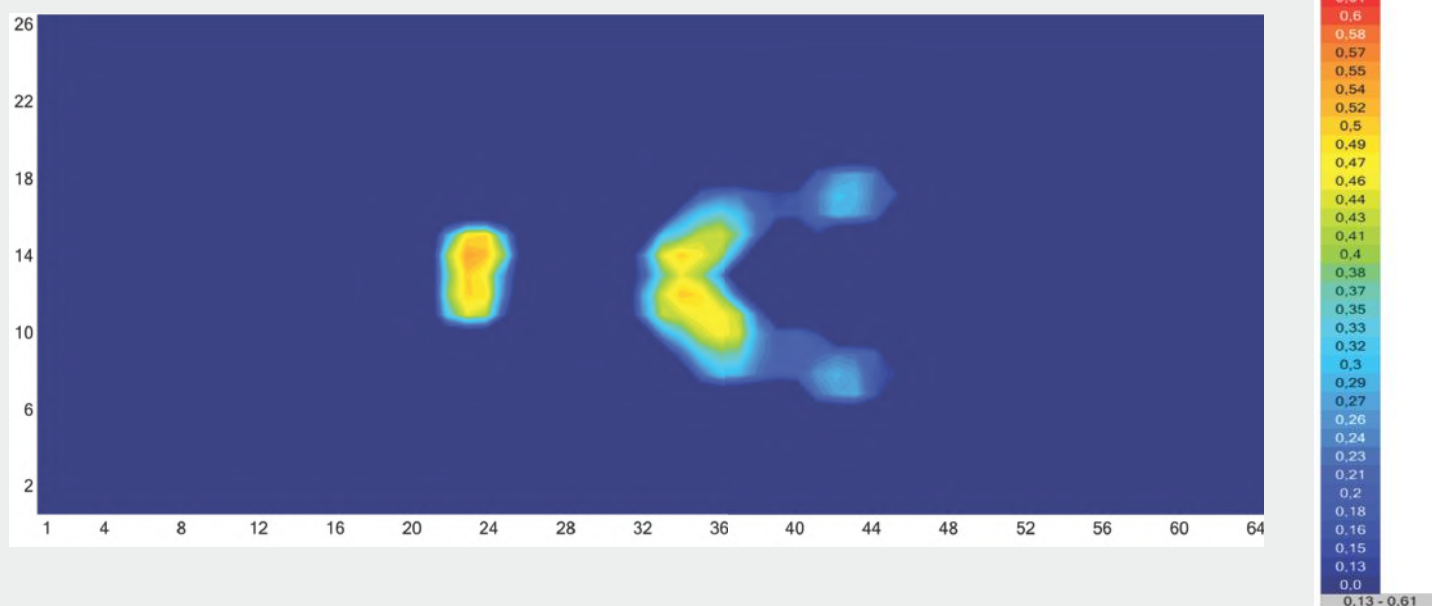



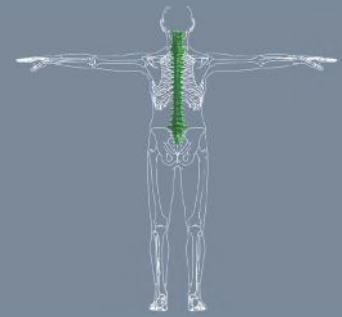

## Strain on the Muscles

With the correct adjustment of the seat and the control panels, the shoulder and neck muscles will not be stressed any more than when doing normal work on a personal computer. If the operator also switches between seated and standing operating positions on the control unit there will be an additional positive effect.



### Surface electromyography

By means of SEMG measurements, the strain on the muscles of the shoulder and neck areas as well as in the area of the lumbar spine were determined in different working positions.

The results show that especially in the area of the lumbar spine the strain/exertion on the muscles can be significantly reduced as compared to conventional seats without adjustable control panels.

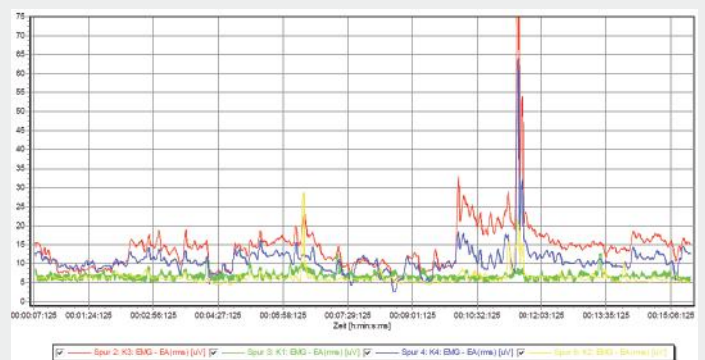
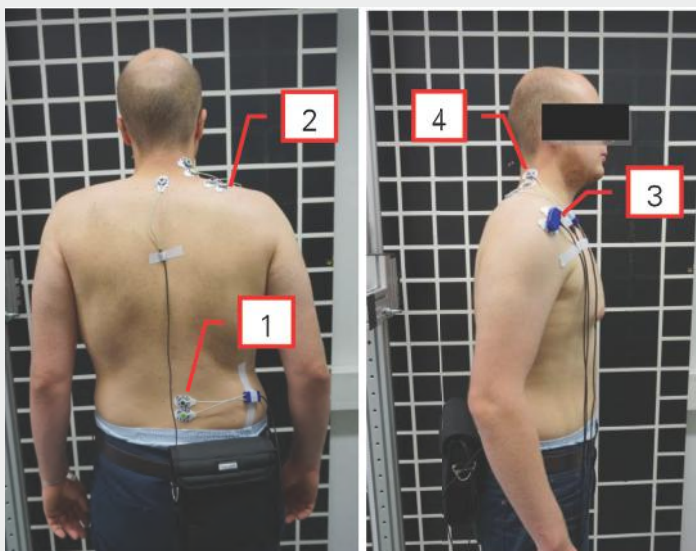

- 1) *musculus erector spinae* 3) *musculus deltoideus*
- 2) *musculus trapezius* 4) *usculus splenius capitis*

# Ergonomics Meets Control Technology

## The swiveling KST 19 control unit



### Adjustment options

- Swiveling control unit (complete unit)
- Horizontal adjustment of seat with control panel
- Height/vertical adjustment of seat including control panels
- Adjustment of backrest
- Horizontal adjustment of seat
- Left/right control panel adjustable
- Horizontal adjustment of control panels
- Height/vertical adjustment of control panels in relation to seat
- Tilt adjustment of control panels
- Hinged monitor holder

### Technical data and relevant standards

Allowed ambient temperature	Operation	-40°C to +60°C
	Storage	-50°C to +80°C
Rated voltage range	Compressor	24 VDC
Climatic resistance		
Damp heat, constant	IEC 60068-2-78	
Damp heat, cyclic	IEC 60068-2-30	
Protection class	IP 54 IEC/EN 60529	



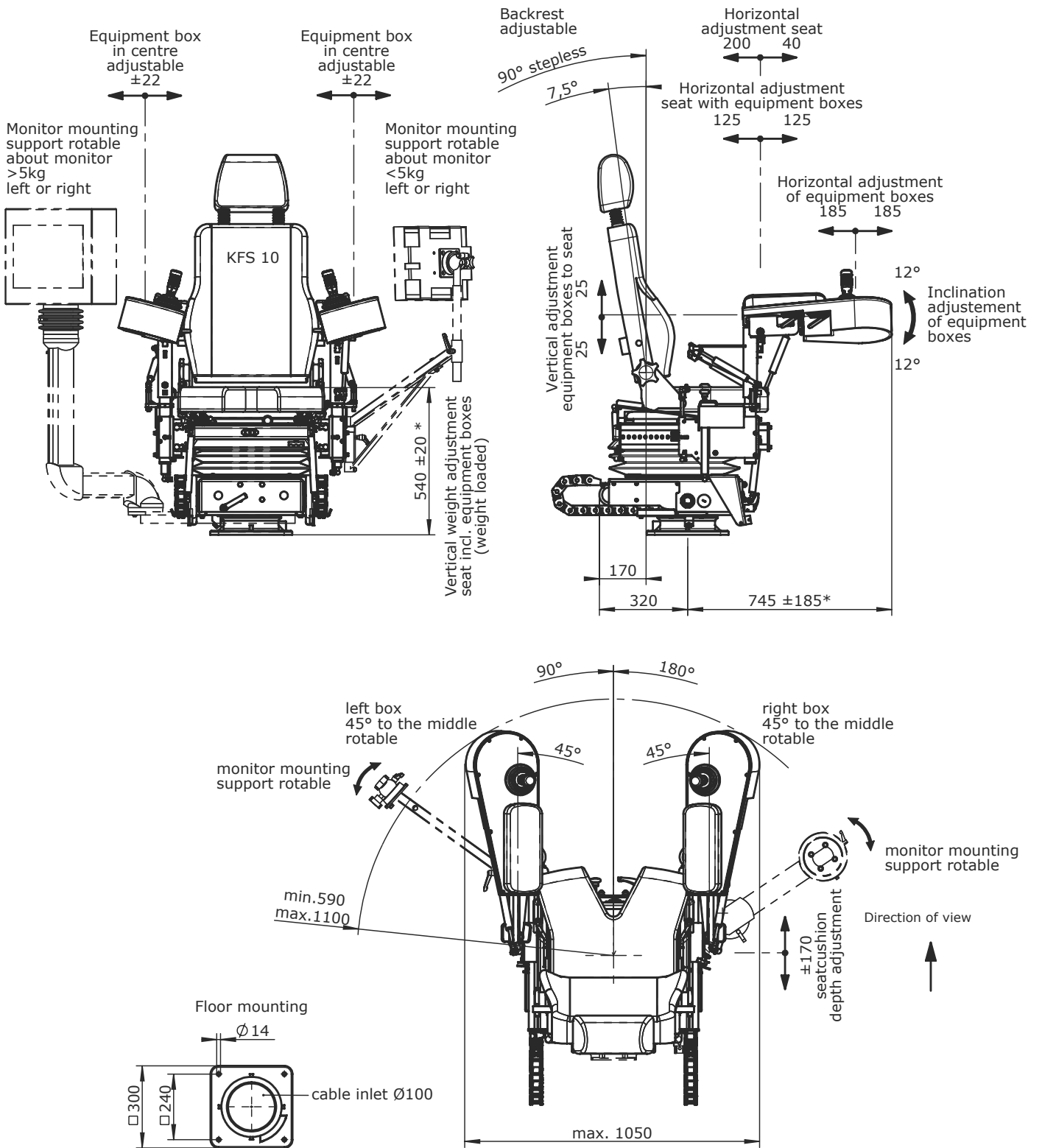
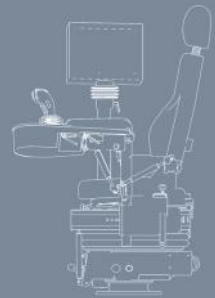

\* adjustable

# Ergonomics Meets Control Technology

## Data base

The procedures and testing methods used in the ergonomic assessment\* are based on the latest findings and codes and standards or implement such. The test results reflect the state-of-the-art.

### Anthropometry and posture analysis

- DIN 33402-2, edition: 2005-12 "Ergonomics - Human body dimensions - Part 2: Values"
- DIN CEN ISO/TR 7250-2, edition: 2013-08 "Basic human body measurements for technological design - Part 2: Statistical summaries of body measurements from national populations (ISO/TR 7250-2:2010 + Amd 1:2013); German edition CEN ISO/TR 7250-2:2011 + A1:2013"
- ISO 11226: Ergonomics – Evaluation of static working postures (Ergonomie – Evaluierung von Körperhaltungen bei der Arbeit) (12.00). Beuth, Berlin 2000
- DIN EN 1005-4, edition: 2009-1 "Safety of machinery - Human physical performance - Part 4: Evaluation of working postures and movements in relation to machinery; German edition EN 1005-4:2005+A1:2008"
- DIN EN ISO 14738, edition: 2005-03 "Safety of machinery - Anthropometric requirements for the design of workstations at machinery (ISO 14738:2002 + Cor. 1:2003 + Cor. 2:2005); German edition EN ISO 14738:2008"
- Rapid Upper Limb Assessment (RULA): McAtamney, L.; Corlett, E.N., 1993
- Ovako Working posture Analysis System (OWAS): Osmo Karhu, et. al., 1973

### Usability and product design

- DIN EN 60447, edition: 2004-12; VDE 0196:2004-12 "Basic and safety principles for man-machine interface, marking and identification - Actuating principles (IEC 60447:2004); German edition EN 60447:2004"
- DIN CEN/TR 614-3/DIN SPEC 33434-3, edition: 2011-03 "Safety of machinery - Part 3: Ergonomic principles for the design of mobile machinery; German edition CEN/TR 614-3:2010"
- DIN EN 894-2, edition: 2009-02 "Safety of machinery - Ergonomics requirements for the design of displays and control actuators - Part 2: Displays; German edition EN 894-2:1997+A1:2008"
- DGUV Information 208-033 (BGI/GUV-I 7011): Belastungen für Rücken und Gelenke – was geht mich das an? [Strains on back and joints – none of my business?] (09.13). Publisher: Deutsche Gesetzliche Unfallversicherung, Berlin 2013

\*The ergonomic assessment was done in the course of the study titled „Expert opinion on the KST 19 control unit“ carried out by the Technical University of Dresden in cooperation with the GWT-TUD GmbH.

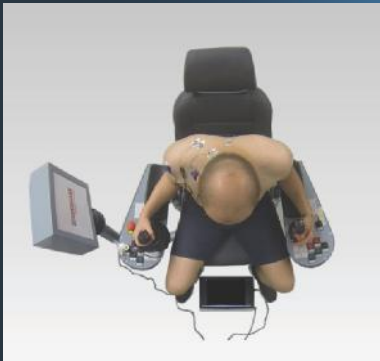

**Ergonomic assessment**

Technical University of Dresden  
 Institute for Technical Logistics and  
 Work Systems  
 Chair of Ergonomics  
[www.tu-dresden.de/mw/tla](http://www.tu-dresden.de/mw/tla)

**Authors of the study**

Prof. Dr.-Ing. Martin Schmauder  
 Dipl.-Ing. Daniel Gröllich

**In cooperation with**

GWT-TUD GmbH

**[www.gessmann.com](http://www.gessmann.com)**

**W. Gessmann GmbH  
Postfach 11 51  
74207 Leingarten  
Eppinger Straße 221  
74211 Leingarten  
Phone +49 7131 40 67-722  
Fax +49 7131 40 67-10  
[sales@gessmann.com](mailto:sales@gessmann.com)  
[www.gessmann.com](http://www.gessmann.com)**

